

GENERAL FEATURES

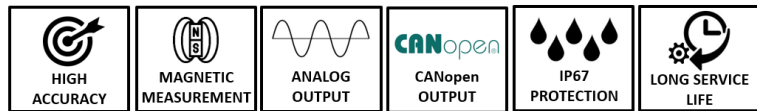

- Absolute measurement with magnetic principle
- 50 mm body diameter
- 6 mm or 8 mm shaft diameter
- 14 bit angular resolution
- Analog or CANopen output options
- Redundant output
- Analogue output signal forms can be selected according to 3 selected points
- High sensitivity
- IP67 Protection class



The SAS series encoders operate absolute. In other words, unlike the incremental systems, they do not lose their positions in power outages and continue to measure from where they left off.

The SAS series single turn absolute rotary encoders offer highly flexible solutions in use, with different output signals, shaft diameters and user-adjustable measuring range. The SAS single turn absolute rotary encoder with integrated reference provides high quality feedback. With its IP67 high protection class, it is resistant to harsh environmental conditions.

APPLICATION AREAS

Speed and position accuracy in one application; If it is more important than fault tolerance and system simplicity, absolute encoders should be used. Absolute encoders provide precise operation in applications.

- Identifying multi-axis orientation in CNC machines used in component manufacturing
- Automatically determine the height of the scissor bearings used in hospitals
- Correct placement of multiple stabilizers for large vehicles such as cranes or air lifts
- Automatic doors or slots to move without limiting key
- Continue robotic movement even after a power failure

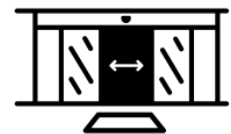

MECHANICAL SPECIFICATIONS

Maximum Speed	3000 rpm
Body Diameter	50 mm
Shaft Diameter	6 mm, 8 mm
Weight	~350 gr
Protection Class	IP 67
Operating Temperature	-20°C ... +85°C
Relative Humidity	%10 ... %90
Material	Shaft: Stainless Steel Body: Aluminium

MECHANICAL DIMENSIONS (mm)

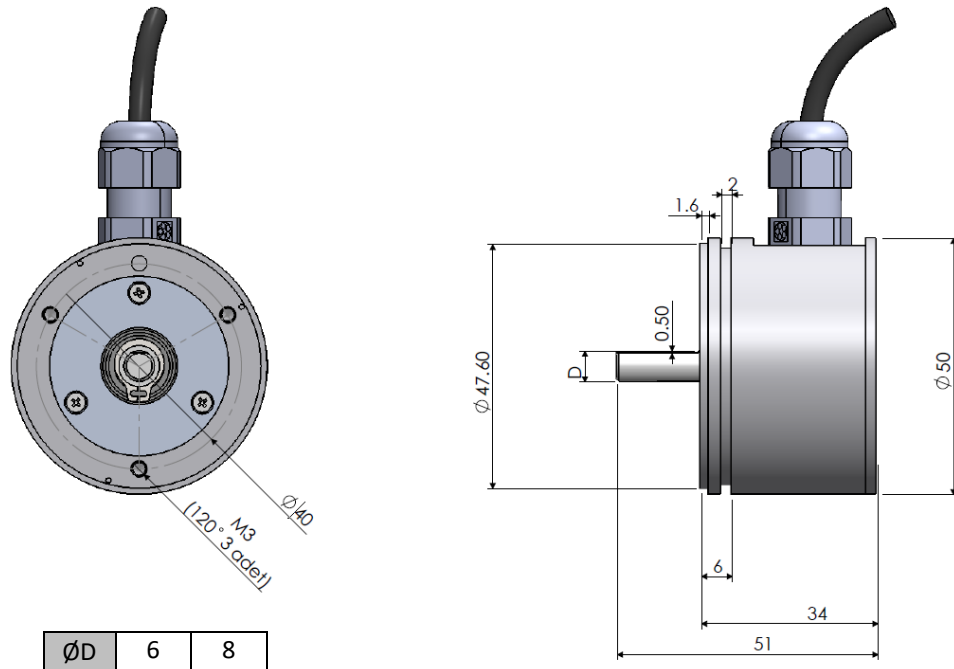

ANALOG VERSION

Electrical Specifications

Working Principle	Hall Effect
Supply Voltage	15 ... 26 VDC
Current Consumption	40 mA
Reverse Polarity Protection	Yes
Measuring Range	0° ... 360°
Accuracy	±0,1°
Repeatability	0,1°
Angular Resolution	14 Bit
Response Frequency	333 Hz
Electrical Interface	4-20 mA, 0-10 V, 0.5- 4.5 V, 0-5 V 20-4 mA, 10-0 V, 4.5-0.5 V, 5-0 V
Electrical Connection	8 x 0,14 mm ² shielded cable
Output Load	For current output model; min 250 Ω For voltage output model; min 1 KΩ

ELECTRICAL CONNECTION

Signal	Cable
U+ (+15...+26 VDC)	Red
Output 1: 0.5-4.5 / 0-10VDC / 0-5VDC / 4-20mA	Gray
GND (0V)	Black
Output 2: 0.5-4.5 / 0-10VDC / 0-5VDC / 4-20mA (optional)	White
Direction Change	Pink
Reset	Green
Programming Tips (these ends should not touch each other and should not be connected)	Yellow, Blue
-	-

RESET: With the reset function you can set the desired location to 0. The reset terminal and GND are short-circuited for about 5 seconds and then disconnected. The sensor then accepts the current position as zero.

DIRECTION CHANGE: You can change the angle increase direction with the direction change function. The direction changing terminal and GND are short-circuited for about 5 seconds and then disconnected. Thus, the sensor reverses the angle direction (CW is CCW and CCW is CW).

DETERMINATION OF OUTPUT SIGNAL FORM

Analog output signal forms can be specified according to request for 3 points as low point, middle point and high point. The requested signal form must be specified at the order stage. Examples of output signal forms are shown below.

Note: The diagrams shown below are for illustrative purposes. Scale value can be selected between 0° - 360° and Output value between 0% and 100%.

Analog Output 1		
Point	Scale	Output
Low Point	0°	%0
Middle Point	180°	%50
High Point	360°	%100

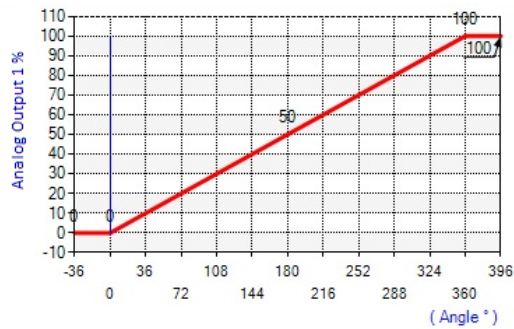

Analog Output 2		
Point	Scale	Output
Low Point	360°	%0
Middle Point	180°	%50
High Point	0°	%100

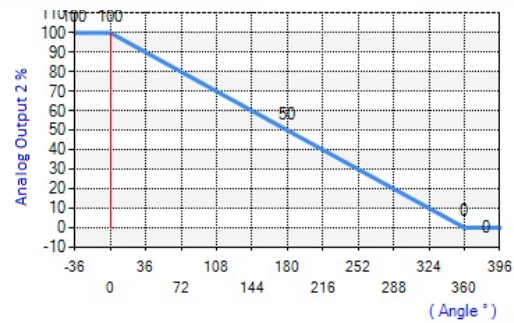

Analog Output 1		
Point	Scale	Output
Low Point	0°	%0
Middle Point	180°	%50
High Point	360°	%100

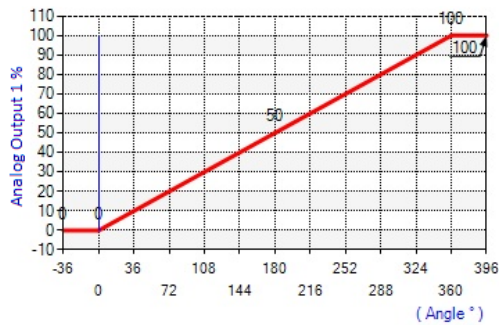

Analog Output 2		
Point	Scale	Output
Low Point	0°	%20
Middle Point	180°	%60
High Point	360°	%100

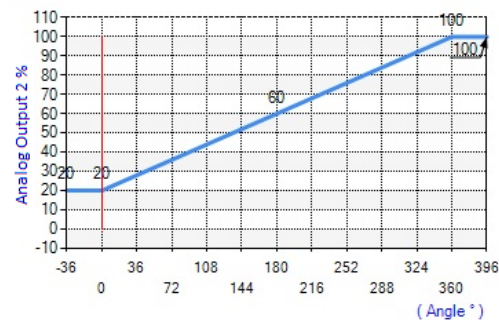

Analog Output 1		
Point	Scale	Output
Low Point	0°	%100
Middle Point	180°	%50
High Point	360°	%0

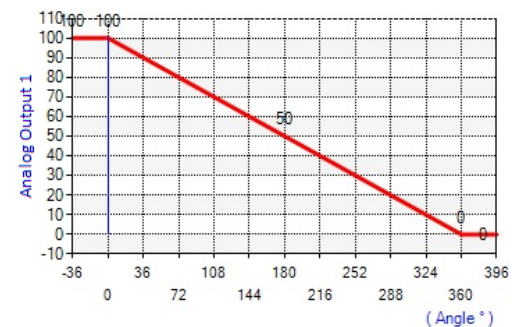

CANOPEN VERSION

Electrical Specifications

Working Principle	Hall Effect
Supply Voltage	12 ... 30 VDC
Current Consumption	40 mA
Reverse Polarity Protection	Yes
Measuring Range	0° ... 360°
Accuracy	±0,1°
Repeatability	0,1°
Angular Resolution	14 Bit
Response Frequency	333 Hz
Electrical Interface	CANopen
Electrical Connection	6x0,34 mm ² twisted shielded cable

CANopen Specifications

Communication Profile	CiA 301
Device Type	CANopen, CiA DS406
Node ID	Between 1 and 127, configurable via LSS or SDO.
Baud Rate	10 kBit/s, 20 kBit/s, 50 kBit/s, 100 kBit/s, 125 kBit/s, 250 kBit/s, 500 kBit/s, 800 kBit/s, 1 Mbit/s
PDO Data Rate	100 ms
Error Check	Heartbeat, Emergency Message
PDO	3 Tx PDO
PDO Modes	Event/Time triggered, Synch/Asynch
SDO	1 server
Position data	Object Dictionary 0x6020
Terminating Resistor	Optional

ELECTRICAL CONNECTION

Signal	Cable
CAN SHIELD	Shield
V+ (12...30 VDC)	Red
GND (0V)	Black
CAN H	Yellow
CAN L	Green

ORDER CODE FOR CANOPEN VERSIONS

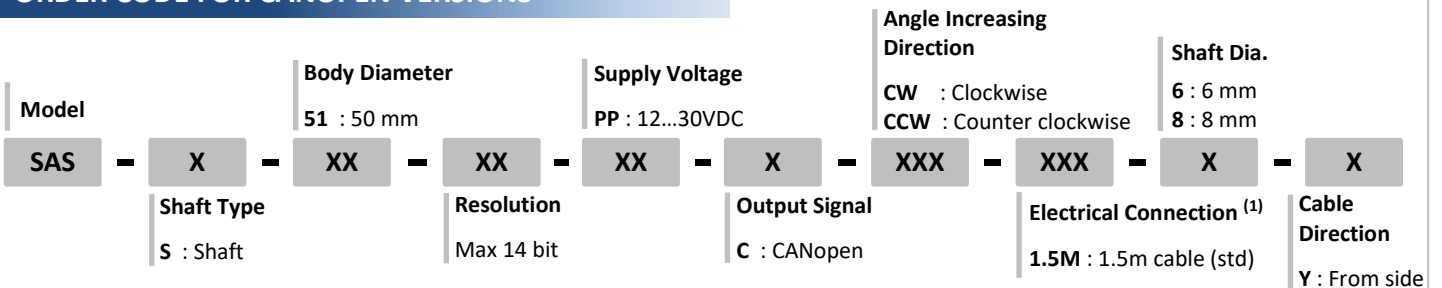

(1) Optionally different cable lengths can be requested.

PM Instrumentation



47 Avenue de l'Europe, 92400 Courbevoie, France



Tel: +33 1 46 91 93 32



Fax: +33 1 46 91 93 39



www.pm-instrumentation.com



contact@pm-instrumentation.com