



Measuring amplifier GSV-3USB

Manual

Updated:	20.06.2019
Version	ba-gsv3usb-v1_en
Editor	
Changelog	Changelog Page 18

Content

Straingage-Measuring amplifier GSV-3USB.....	4
Description.....	4
Models available to order.....	5
Connectors.....	6
Pin assignment (full-, half, quarter bridges, distance sensors).....	6
Connection diagram for quarter bridges and half bridges.....	6
Connection diagram for potentiometric distance sensors.....	7
Terminal assignment.....	8
Connection of sensors with ± 10 Volt output.....	8
Terminal assignment for current input.....	8
Speed measurement.....	8
Connection of the HAL501 hall switch.....	9
Connection of dual track pulse generators.....	9
Connection of a torque sensor DR-2335.....	10
Configuration.....	10
Technical data.....	11
Adapting the measuring amplifier.....	14
Terminal assignment on the platinum subsurface.....	14
straingage full bridges.....	15
straingage quarter bridges.....	15
Potentiometric transmitter, displacement sensors.....	16
Voltage input -10V...+10V.....	16
Current input -20mA ...+20mA.....	17
Advice for the USB interface.....	18
Notes on the threshold pick-up.....	18
Changelog.....	18

Straingage-Measuring amplifier GSV-3USB



Figure 1: 1-channel, front view



Figure 2: 2-channel, front view

- Powered via USB port
- Sampling rate 10 kHz
- Data rate 1...1000 Hz
- straingage quarter, half, full bridges
- Built-in bridge competition 350 Ohm
- Optional configuration for displacement transducers
- Comprehensive software support
- Galvanic isolation to USB port
- Optional version for connection of torque sensors with incremental encoder available

Description

This measuring amplifier for sensors with wire strain gauges is equipped with a USB interface, while power is supplied via the USB port on the rear of the measuring amplifier. The measuring amplifier is also available in a 2-channel version (GSV-3USBx2).

A 15-pole Sub-D socket is included for connecting sensors.

The dual-channel measuring amplifier features sensor connections via two round plug connectors.

The stand-out features include its high sampling rate of 10kHz and the high 16 bit resolution, as well as the exceptional command set provided to configure the measuring amplifier via ASCII control codes or a Windows DLL.

This measuring amplifier can also be configured via solder bridges when analysing straingage quarter bridges (e.g. 350 ohm) or for a power supply of ± 10 V .

It can also be optionally supplied for connecting potentiometric displacement transducers or for power input of 4...20mA , as well as for incremental encoders.

Models available to order

Type	Description
GSV-3USB 2mV/V	Input ± 2 mV/V, 1x SubD15, (standard type, 95% of all sensors with strainage)
GSV-3USB 3.5mV/V	Input ± 3.5 mV/V 1x SubD15, (e.g. for KD9363s)
GSV-3USBx2 2mV/V	2 channels, 2x Input ± 2 mV/V, 2x M12 socket
GSV-3USBx2 2mV/V 10V	2 channels, Port "A" strainage sensor, Port "B" ± 10 V input, 2x M12 socket
GSV-3USBx2 2mV/V 4.2V	2 channels, Port "A" strainage sensor, Port "B" potentiometric sensor, 2x M12 socket
GSV-3USBx2 2mV/V RPM	2 channels, Port "A" strainage sensor, Port "B" pulse generator with direction, 2x M12 socket
GSV-3USBx2 2mV/V RPM/SubD15	2 channels, Port "A" strainage sensor, Port "B" pulse generator with direction, 1x SubD15

Other models available on request;

Connectors

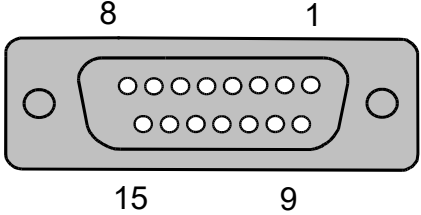
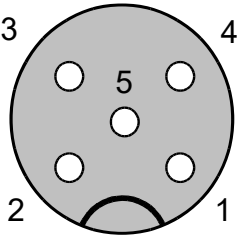
GSV-3USB	GSV-3USBx2
 <p>One connector Sub-D15, female available</p>	 <p>Two connectors M12 5pole, female available</p>

Pin assignment (full-, half, quarter bridges, distance sensors)

15-pole Sub-D15	5-pole M12	Description	Colour code for cables	
1		GND (= -US)	Shielding	
5	2	-US negative bridge power supply	white	white
6	1	+US positive bridge power supply	brown	brown
8	3	+UD positive differential input	green	blue
15	4	-UD negative differential input	yellow	black
14	5	AUXin customisable input	grey	grey
2		TARA control input for zero setting function		
3		VCC_T voltage 5.6V DC, 1mA		
9		Aout analogue output 0.1V...4.8 V		
10		SW threshold switch		

- In the 1-channel GSV-3USB, the shield is connected to PIN 1.
- In the 2-channel GSV-3USBx2 with a round plug connector, the shield is placed on the plug housing.
- Alternatively, the shield is placed on PIN 2 of the round plug connector

Connection diagram for quarter bridges and half bridges

Please note: When connecting quarter or half bridges, the measuring amplifier must be correctly configured. Closing two solder bridges connects together the three additional resistors.

Wire strain gauge-quarter bridges are connected using three-wire technology, which reduces the impact of the supply cable on the zero point, and halves zero point drift.

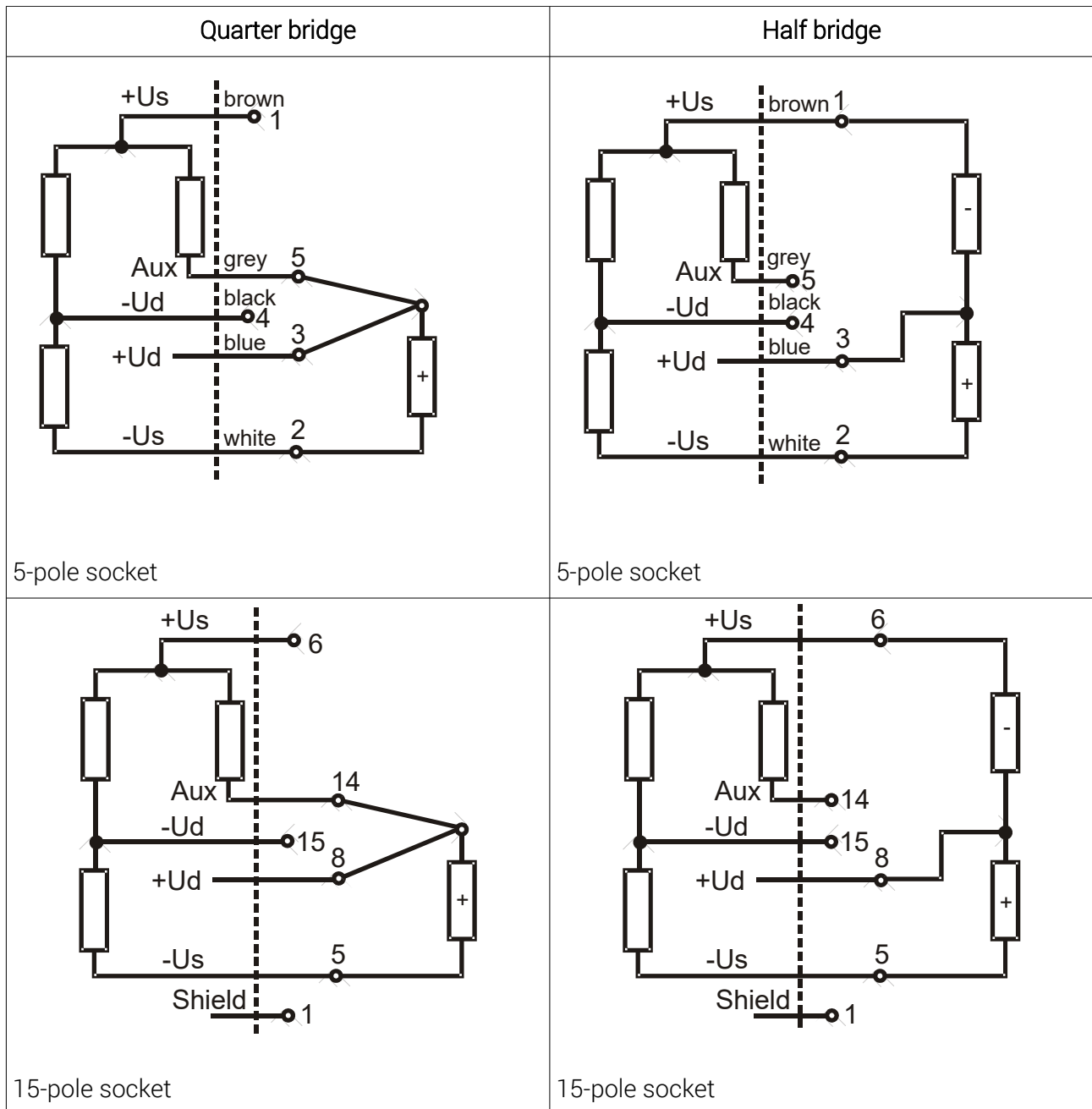

Connection diagram for potentiometric distance sensors

The GSV-3USB and GSV-3USBx2 measuring amplifiers are available in a design for connection to potentiometric distance sensors (linear potentiometer or tackle way receiver), which involves the slider of the distance sensor being connected to the "Aux" input of the measuring amplifier.

The distance sensor is powered via the sensor power supply +Us and -Us.

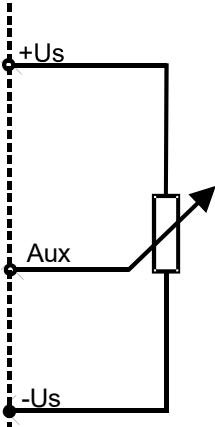
Distance Sensor	
	<p>The potentiometric distance sensor is connected between +Us, -Us and AUX.</p> <p>The power supplied to the potentiometric distance sensor is at 4.2V.</p> <p>The input scope includes the ability to handle voltages of 0...4.2V.</p>

Terminal assignment

Designation	5-pole socket GSV-3USB	15-pole SUB-D socket GSV-3USB
Positive supply +Us	1	6
Negative supply -Us	2	5
Input "Aux"	5	14

Connection of sensors with ± 10 Volt output

Designation	5-pole socket GSV-3USB	15-pole SUB-D socket GSV-3USB
± 10 Volt	3	8
Measuring signal mass	4	15
Shield	Housing	1

Terminal assignment for current input

Designation	5-pole socket GSV-3USB	15-pole SUB-D socket GSV-3USB
± 20 mA	3	8
Measuring signal mass	4	15
Shield	Housing	1

Speed measurement

GSV-3USB and GSV-3USBx2 measuring amplifiers are available in models capable of measuring speed. This involves the connection of a hall switch as a sensor, which is

triggered by one, two, four or eight magnets per revolution. The threshold level at which the speed measurement pulse is detectable is a change in the magnetic flow density from 20mT to 4mT, whereby the magnetic south pole must be facing the sensitive surface of the hall switch.

The unit must be configured to rpm and the output reading of the measurement values is set to text format by default. The default scaling is set to 20000 and cannot be changed. The number of magnets generating pulses on the hall sensor can be configured using gsvterm.exe. For this purpose, please use the menu option "Special settings" within the program interface on page 2.

Connection of the HAL501 hall switch

Function	5-pole socket M12 GSV-3USBx2	15-pole SUB-D socket GSV-3USBx1	HAL501, customised
Mass (GND), shield	2	1	Brown (pin 2)
Supply +5V	1	3	White (pin 1)
Hall switch signal	3	13	Green (pin 3)

Instead of the HAL501 hall switch, other transmitters with a power consumption under 5V, 5mA and an output signal with TTL Pegel can be connected.

The use of a rod magnet NdFeB 20mmx10mmx4mm enables a working distance of up to 10mm between the hall switch and the magnet.

Number of magnets	Speed range in RPM		Response time in terms of number of rotations	
	Minimum	Maximum	Minimum	Maximum
1	18	36000	Around 1	Around 2
2	9	18000	Around 1/2	Around 1
4	4.5	9000	Around 1/4	Around 1/2
8	2.25	4500	Around 1/8	Around 1



Figure 3: Hall switch HAL501 within the TO92 housing, note the sensitive surface position (should be facing the magnetic south pole)

Connection of dual track pulse generators

GSV-3USB and GSV-3USBx2 measuring amplifiers are available in models capable of measuring rotation angle/speed or travel distance. For this purpose, an incremental pulse



generator is connected, which emits phase-shifted square signals in the event of a change in travel distance or rotation angle through 90° (connections A and B).

Function	5-pole socket M12 GSV-3 USBx2	15-pole SUB-D socket GSV-3 USBx1
Mass (GND), shield	2	1
Supply +5V	1	3
Pulse signal A	3	12
Pulse signal B	4	13

Connection of a torque sensor DR-2335

A dual-channel measuring amplifier GSV-3USBx2 2mV/V/RPM/Sub-D15 is recommended for operating the DR2335 sensor.

Lines "A" to "M" of the DR2335 sensor are connected to the SubD-15 socket of the measuring amplifier.

Configuration

Port "A"	Port "B"
"Log mode" off	"Log mode" on
Scaling factor 2 mV/V or a corresponding factor calculated for the sensor parameter.	Scaling factor 31207.6 for the display in angular degrees. The resolution is 0.5°.

The data frequency is configured to port "A" . Port "B" transmits synchronously with the data frequency of port "A".

Port "B" functions as an incremental counter and is not automatically reset to zero. After reaching the figure 65535°, it reverts to zero.

The command "SetZero" can be used to reset the counter to 0 at any time.

DR2335 signals	DR2335 12-pole plug connector	GSV-3USB 5-pole M12 socket; Port "A"	GSV-3USB 5-pole M12 socket; Port "A"	GSV-3USB SubD15 socket; Ports "A+B"
straingage Us+	B	1 (brown)		6
straingage Us-	A	2 (white)		5
straingage Ud+	C	3 (blue)		8
straingage Ud-	D	4 (black)		15
Counter +5V (Vcc)	F	-	1 (brown)	11
Counter GND	E and J (where applicable, connected)	-	2 (white)	7
Counter A	G	-	3 (blue)	12
Counter B	H	-	4 (black)	13
Shields	M	Cable shield	Cable shields	1

Technical data

	GSV-3USB	Unit
Accuracy class	0.1	%
Measurement range (v.E.)	2 optional 1,0 or 3,5	mV/V mV/V
Connectable wire strain gauge range	120 bis 5000	Ohm
Bridge supply voltage	4.2 ±0.2	V V
Input impedance	>20 / 300pF	MOhm
Common mode rejection		
DC	100	dB
100Hz	80	dB
Deviation in linearity	<0.02	% v.E.
Temperature impact on zero point per 10K	<0.1	% v.E.
Temperature impact on measurement sensitivity per 10K relative to the measured value	<0.1	% v.S.
Output filter		



	GSV-3USB	Unit
3dB limit frequency analogue, Bessel, 3.Ordnung Digital output filter	1,250 FIR-Filter + configurable MW filter	kHz
Data frequency	0.00 ... 1220.00	Hz
Measuring frequency	76.80 Hz ... 10080.67	Hz
Resolution	±15 Bit	
Analogue output		
Working range	2.5 ±2.25	V
Usage range	0.01 ... 5.2	V
Zero balance		
Tolerance	<5, type <2,	mV
Time period	<90	ms
Falling edge resolution after at least 4ms high level (3.5V ... 30V or supply voltage)		
Interface	USB 2.0	
Supply voltage		
Working range	4.5...5.5 via USB port	V DC
Power consumption with nominal voltage per channel with 350 ohms Full bridge	< 120	mA
Parameter memory	Four complete sets of parameters can be saved in the EEPROM. 1. Last setting 2. Default setting 3. User 1 4. User 2	
Working temperature range	-10...+65	°C
Storage temperature range	-40...+85	
Dimensions (L x W x H)	126 x 85 x 25	mm
Protection type for housing models (DIN 40 050)	IP40	

Abbreviations:

v.E. (from end value), v.S. (from target value)

The attainable signal/noise ratio depends on the ambient conditions (cable length, shielding), the configured data rate and the FIR filtration which can be optionally applied. The figure below shows the resolution with a connecting cable 1m in length, measurement range $\pm 2\text{mV/V}$, FIR filter switched off.

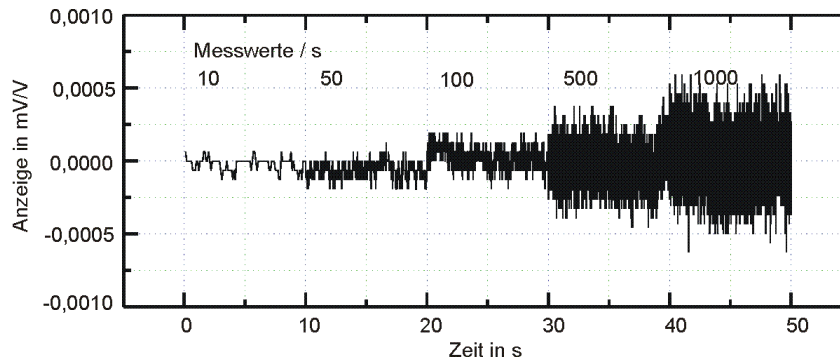

Adapting the measuring amplifier

Using solder bridges on the platinum subsurface, the measuring amplifier can be configured into a range of operating modes. Two screws on the front side can be removed to open the housing. The screws are covered with black cover caps.

The measuring amplifier includes an add-on for quarter bridges with 350 ohm and this configuration can be activated using solder bridges. With the "quarter bridge / half bridge" configuration, half bridges are also connectable from 120 ohm.

Additional adaptations include voltage input $\pm 10V$, current input 4...20mA, input for potentiometer transmitters.

Terminal assignment on the platinum subsurface

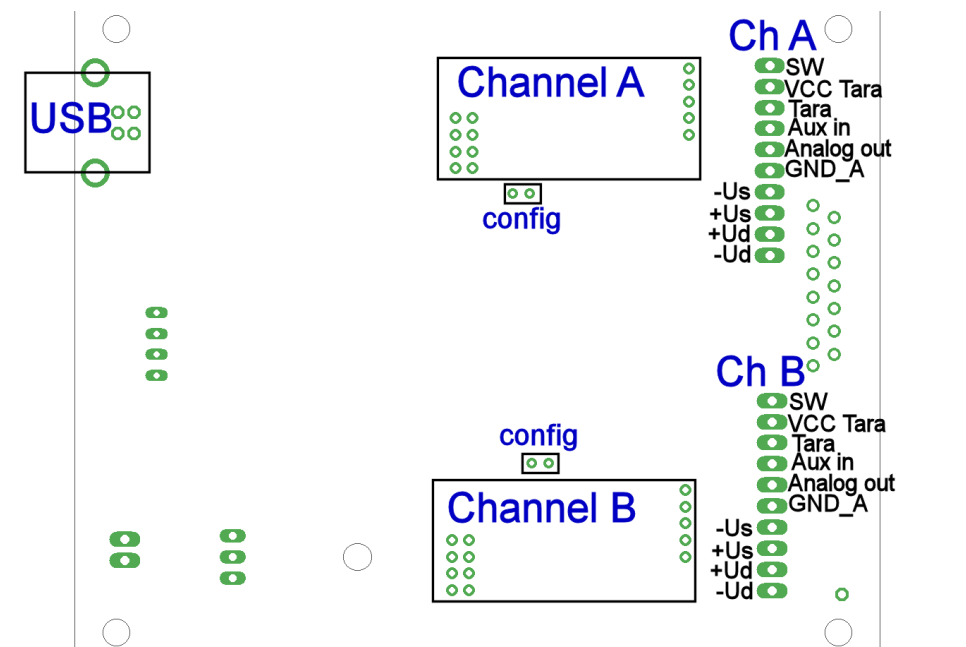

Figure 4: Pin assignment, platinum subsurface

straingage full bridges

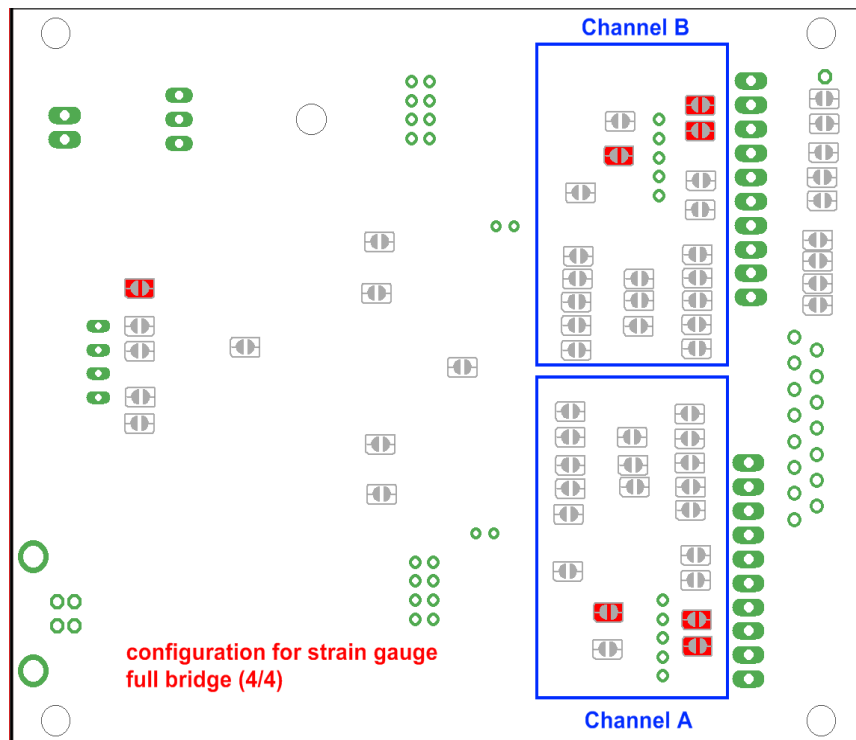

Figure 5: straingage full bridges

straingage quarter bridges

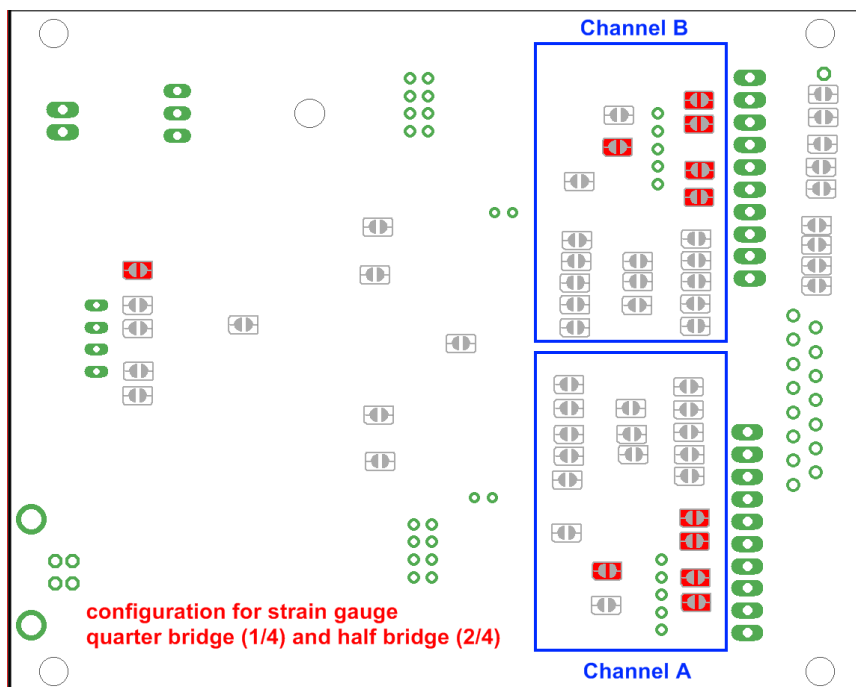

Figure 6: straingage quarter bridge 350 ohm and half bridge (120 ...5000 ohm)

Potentiometric transmitter, displacement sensors

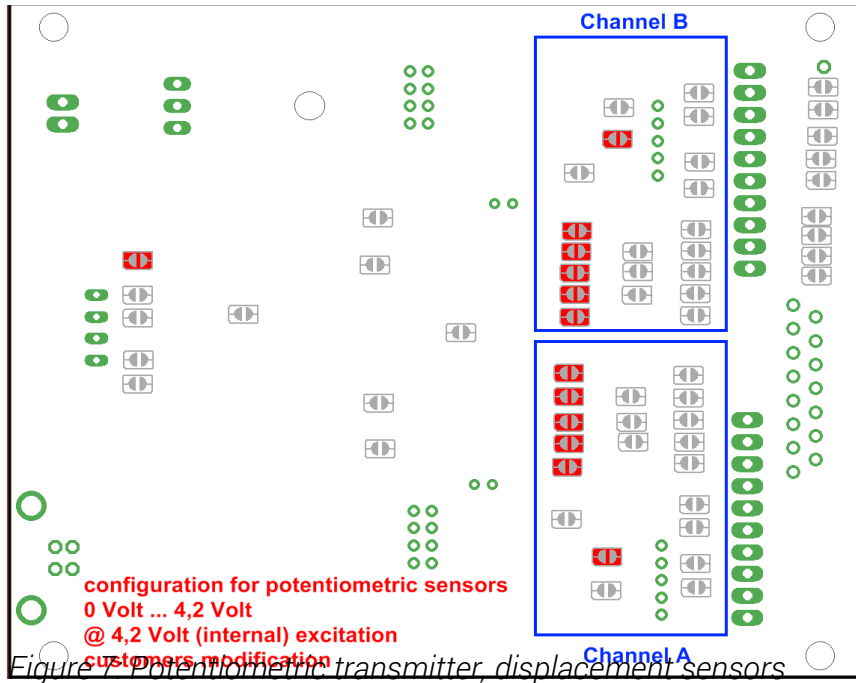

Figure 7: Potentiometric transmitter, displacement sensors

Voltage input -10V...+10V

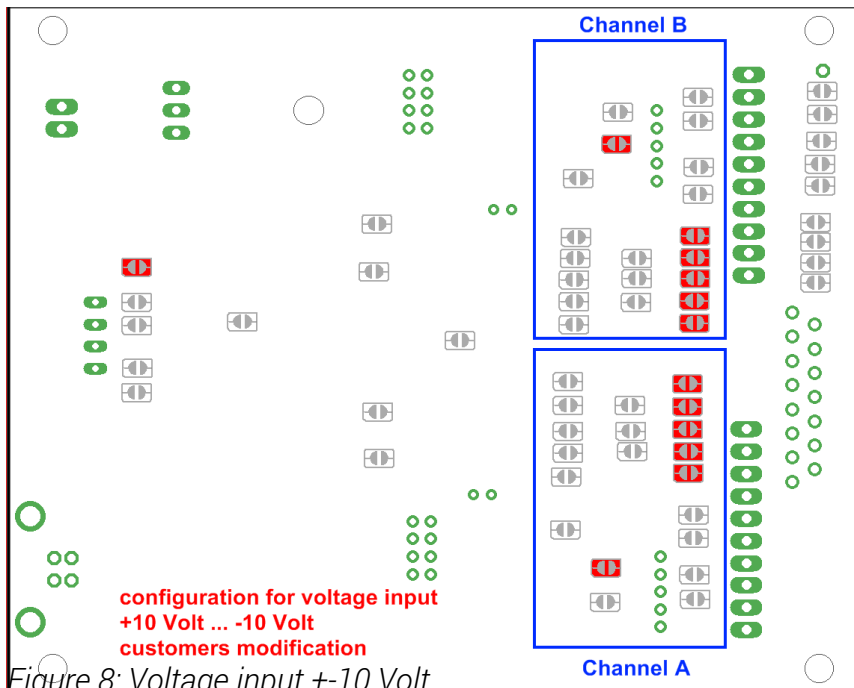

Figure 8: Voltage input +/-10 Volt

Current input -20mA ...+20mA

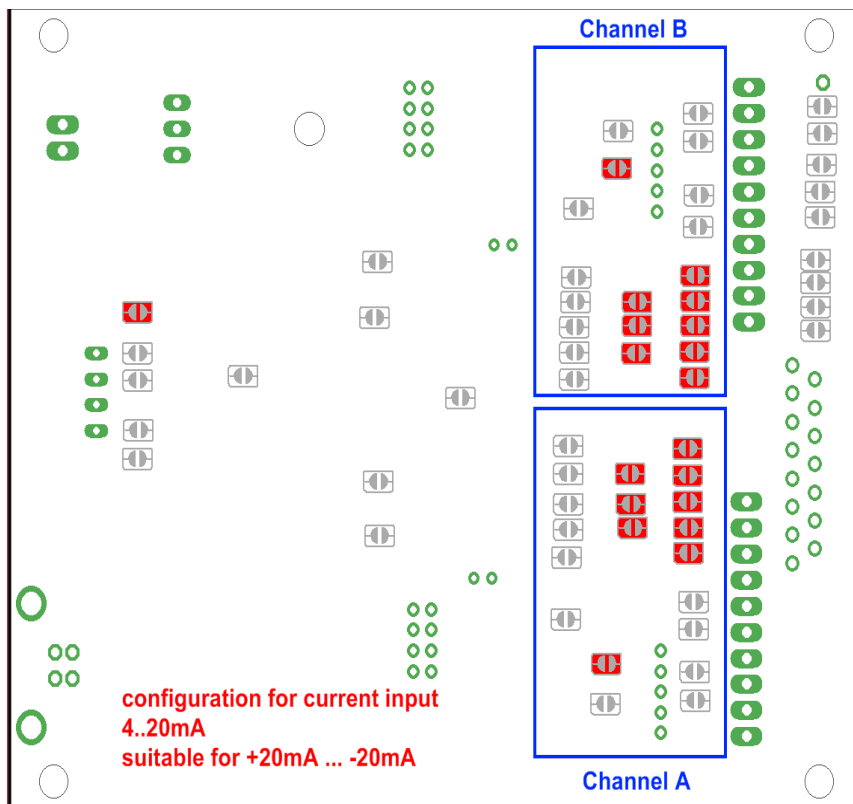

Figure 9: Current input 4-20mA

Advice for the USB interface

Switching on electrical devices (laboratory power supplies, power supplies, engines, heating coils, neon lights) can lead to the computer USB interface shutting down. In the event of any problems, the computer should be supplied via a isolating transformer or via a separate electrical circuit.

There are several ways of improving the reliability of the USB interface of the PC or laptop:

- Use a high-quality USB cable with a ferrite core,
- Reduce the number of USB devices used, since the overall current is limited to 500mA,
- Use an active (self-powered) USB hub,
- Use laptop power supplies with grounding.

The use of an active USB hub with its own power supply is particularly helpful for improving the reliability of the USB interface.

Notes on the threshold pick-up

Threshold pick-up

The transformer will trip if the limit value is exceeded. The maximum switching current is 200mA.

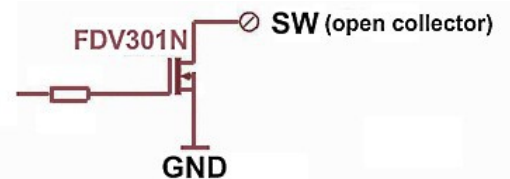

Changelog

Version	Changes
ba-gsv3-v1:en.odt	First Version



Subject to change without notice.

All information describes our products in general form.

They are not warranted characteristics in the sense of §459 Paragraph 2, BGB (German Civil Code) or similar regulations and affect no liability.

Made in Germany

Copyright © 2017
ME-Meßsysteme GmbH
Printed in Germany